

BENCHTOP CENTRIFUGES

UNIVERSAL 320 | 320 R

A UNIVERSAL CHOICE

The UNIVERSAL 320 is a compact, versatile and indispensable general purpose centrifuge. Excellent performance and a comprehensive range of accessories enable the UNIVERSAL 320 to carry out virtually any centrifuging tasks including plates, blood tubes, cell culture, microliter and cytology.

This unit is available with refrigeration and a temperature range from -20 °C to +40 °C (UNIVERSAL 320 R).



HIGHLIGHTS

- RPM: 500 - 16,000 min⁻¹
Adjustable in increments of 10
- max. RCF: 24,900
- max. capacity: 4 x 200 ml / 6 x 94 ml
- the universal choice among the benchtop centrifuges
- choice of 18 rotors
- IVD-conform according to directive 98/79/EC
- noise level of 48 dB(A) with angle rotor 1611
- impulse button for short centrifugation
- easy operation with keypad and control knob
- impulse key for short cycle mode
- 9 program memories
- 9 individual acceleration and 10 deceleration stages
- model 320 R coolable from -20 to +40 °C with pre-cooling function

FEATURES

- metal housing and lid
- viewing port in the lid
- powered lid lock
- lid dropping protection
- emergency lid lock release
- stainless steel chamber
- automatic rotor recognition
- brushless drive
- error display
- imbalance switch-off
- backlit panel with actual values of all parameters
- auditory message after completion of the centrifugation run

TECHNICAL DATA

	UNIVERSAL 320 classic	UNIVERSAL 320 R cooled
voltage *)	200 – 240 V 1 ~	200 – 240 V 1 ~
frequency	50 – 60 Hz	50 – 60 Hz
consumption	400 VA	800 VA
emission, immunity	EN/IEC 61326-1, class B	EN/IEC 61326-1, class B
max. capacity	4 x 200 ml / 6 x 94 ml	4 x 200 ml / 6 x 94 ml
max. RPM	16,000 min ⁻¹	16,000 min ⁻¹
max. RCF	24,900	24,900
running time	1sec – 99 min: 59 sec, ∞ continuous run, short cycle mode (impulse button)	1sec – 99 min: 59 sec, ∞ continuous run, short cycle mode (impulse button)
dimensions (WxDxH)	401 x 529 x 346 mm	407 x 698 x 346 mm
weight	approx. 31 kg	approx. 52 kg
noise level	48 dB (A) with rotor 1611	50 dB (A) with rotor 1611
temperature control, infinitely variable	-	from -20 to +40 °C
Cat. No.	1401	1406
100 – 127 V 1 ~ / 50–60 Hz *)	1401-01	1406-01
consumption	400 VA	950 VA
emission, Immunity	FCC class B	FCC class B

*) Other voltages on request.

AVAILABLE ROTORS

SWING-OUT ROTORS	angle	max. RPM	max. capacity	Cat. No.	page
swing-out rotor, 4-places	90°	4,500 min ⁻¹	4x200 ml	1554	3
swing-out rotor, 4-places	90°	5,000 min ⁻¹	4x100 ml	1494	6
swing-out rotor, 4-places	90°	4,000 min ⁻¹	4x100 ml	1624	9
swing-out rotor, 4-places	90°	4,500 min ⁻¹	4x100 ml	1324	12
swing-out rotor, 8-places	90°	4,000 min ⁻¹	8x15 ml	1611	14
swing-out rotor, 12-places	90°	5,000 min ⁻¹	12x15 ml	1628	14
swing-out rotor, 8-places	45°	5,000 min ⁻¹	8x50 ml	1617	15
swing-out rotor, 6-places	90°	4,000 min ⁻¹	6x50 ml	1619	15
swing-out rotor, 2-places	90°	4,000 min ⁻¹	10 plates	1460	16
swing-out rotor, 24-places	90°	13,000 min ⁻¹	24x2 ml	1555	16
ANGLE ROTORS					
angle rotor, 24-places	50°	16,000 min ⁻¹	24x2 ml	1552	17
angle rotor, 30-places	45°	14,150 min ⁻¹	30x2 ml	1553	17
angle rotor, 8-places	45°	13,000 min ⁻¹	8 x 8	1551	18
angle rotor, 18-places	45°	14,150 min ⁻¹	18 x 5 ml	1627	18
angle rotor, 6-places	35°	9,000 min ⁻¹	6x85 ml	1556	19
angle rotor, 12-places	35°	6,000 min ⁻¹	12x15 ml	1613	20
angle rotor, 12-places	35°	12,000 min ⁻¹	12x15 ml	1615	21
angle rotor, 8-places	45°	4,500 min ⁻¹	8x50 ml	1418	22

SWING-OUT ROTOR, 4-PLACE | 1554



Rotor	
max. RPM max. RCF	4,500 min ⁻¹ 3,328
max. capacity	4 x 200 ml
run-up run-down, braked in sec	28 31
angle max. noise level	90° 60 dB (A)
temperature in °C ¹⁾	-8
Cat. No.	1554



Bucket	
Lid bioseal ⁵⁾	1561
Cat. No.	1560
Bucket without clamp lock¹⁴⁾	
Cat. No.	1565



Vessels	
capacity in ml	1.5 2.0 5 5 6 7 9 15 15 25 50 94 100 125 150
Ø x L in mm	11 x 38 11 x 38 17 x 59 12 x 75 12 x 82 12 x 100 14 x 100 17 x 100 18 x 102 24 x 100 34 x 100 38 x 102 44 x 100 51 x 100 51 x 116
max. RCF ²⁾	3,328 2,332 3,328 3,215 3,215 3,215 3,215 3,215 3,260 3,056 3,147 3,260 3,147 3,328 3,328
radius in mm	147 103 147 142 142 142 142 142 144 135 139 144 139 147 147
Cat. No.	microliter tubes tubes²⁾ 0536 -

Adapter	
boring Ø x L in mm	11.5 x 39 11.5 x 39 17 x 52 13.5 x 60 13.5 x 60 13.5 x 60 17.5 x 60 17.5 x 60 18.5 x 74 25.2 x 66 35.2 x 69 38.5 x 74 45.5 x 69 52 x 77 52 x 77
vessels per rotor	56 56 16 28 28 28 20 20 16 4 4 4 4 4 4 4
Cat. No.	1571 1571 1593 1589 1589 1589 1588 1588 1572 1573 1574 1575 1576 1594 1594

Vessels	
capacity in ml	200 1.1-1.4 2.6-3.4 4.9 2.7-3 4.5-5 4-5.5 7.5-8.5 9-10 10 1.6-5 4-7 4-7 8.5-10 12
Ø x L in mm	56 x 112 8 x 66 13 x 65 13 x 90 11 x 66 11 x 92 15 x 75 15 x 92 16 x 92 15 x 102 13 x 75 13 x 100 16 x 75 16 x 100 17 x 102
max. RCF ²⁾	3,328 3,215 3,215 3,215 3,215 3,215 3,215 3,215 3,215 3,215 3,215 3,215 3,215 3,215 3,215
radius in mm	147 142 142 142 142 142 142 142 142 142 142 142 142 142 142
Cat. No.	0555 blood collection / urine vessels

Adapter	
boring Ø x L in mm	57 x 77 13.5 x 60 13.5 x 60 13.5 x 60 13.5 x 60 13.5 x 60 17.5 x 60 17.5 x 60 17.5 x 60 17.5 x 60 13.5 x 60 13.5 x 60 17.5 x 60 17.5 x 60 17 x 74
vessels per rotor	4 28 28 28 28 28 20 20 20 20 28 28 20 20 12
Cat. No.	- 1589 1589 1589 1589 1589 1588 1588 1588 1588 1589 1589 1588 1588 1591

Vessels	
capacity in ml	11 15 15 30 50 12 25 30 50 10 30 50 85 94 30
Ø x L in mm	16 x 110 17 x 120 17 x 120 25 x 110 29 x 115 17 x 100 25 x 90 15 x 110 29 x 115 16 x 80 26 x 95 29 x 107 38 x 106 38 x 102 44 x 105
max. RCF ²⁾	3,260 3,328 3,328 3,328 3,328 3,260 3,328 3,328 3,328 3,215 3,260 3,260 3,260 3,260 3,192
radius in mm	144 147 147 147 147 144 147 147 147 142 144 144 144 144 141
Cat. No.	Nunc³⁾ tubes with screw cap 0534⁶⁾

Adapter	
boring Ø x L in mm	17.5 x 74 17 x 77 17 x 77 26 x 77 30 x 77 17.5 x 74 26 x 65 26 x 65 30 x 77 16.5 x 60 26 x 74 29 x 74 38.5 x 74 38.5 x 74 45 x 71
vessels per rotor	16 8 12 4 4 16 4 4 4 20 4 4 4 4 4
Cat. No.	1581 1577 1595 1578 1579 1581 1582 1582 1583 1584 1585 1586 1575 1575 1587

2) Please note that the RCF values indicated refer only to rotor performance. The max. permissible RCF of tubes used should be verified with the individual manufacturers. The max. RCF for glass tubes annotated with footnote 2) is 4,000.
 3.2) When using these tubes, bucket 1560 cannot be closed with lid 1561.
 5) Tested by the TÜV in conformity with DIN EN 61010, section 2 - 020.
 6) A rubber stopper for closing the tube for agitating or mixing is available under Cat. No. 0535. The tube may not be centrifuged with the stopper.
 14) With the E3922 add-on kit and the 1561 lid, the 1565 carrier can be converted at a later time to a 1560 carrier with single-hand clamp lock.

SWING-OUT ROTOR, 4-PLACE | 1554



Rotor

max. RPM max. RCF	4,500 min ⁻¹ 3,328
max. capacity	4 x 50 ml
run-up run-down, braked in sec	28 31
angle max. noise level	90° 58 dB (A)
temperature in °C ¹⁾	-8
Cat. No.	1554



Bucket

Cat. No.	1559
-----------------	-------------



Vessels

capacity in ml	5	6	7	9	15	2.6-3.4	2.7-3	4-5.5	4.5-5	4.9	9-10	10	1.6-5	4-7	4-7
Ø x L in mm	12x75	12x82	12x100	14x100	17x100	13x65	11x66	15x75	11x92	13x90	16x92	10x102	13x75	13x100	16x75
max. RCF ²⁾	3,192	3,192	3,192	3,260	3,260	3,192	3,192	3,124	3,192	3,192	3,260	3,260	3,192	3,192	3,124
radius in mm	141	141	141	144	144	141	141	138	141	141	144	144	141	141	138
Cat. No.	tubes²⁾					blood collection / urine vessels									



Adapter

boring Ø x L in mm	13.4x57.5	13.4x57.5	13.4x57.5	17.5x81	17.5x81	13.4x57.5	13.4x57.5	17.5x81	13.4x57.5	13.4x57.5	17.5x81	17.5x81	13.4x57.5	13.4x57.5	17.5x81
vessels per rotor	20	20	20	16	16	20	20	16	20	20	16	16	20	20	16
Cat. No.	1486	1486	1486	1482A	1482A	1486	1486	1482A	1486	1486	1482A	1482A	1486	1486	1482A

Vessels

capacity in ml	8.5-10	8	12	15	50	12	50
Ø x L in mm	16x100	16x125	17x102	17x120	29 x 115	17x100	29x115
max. RCF ²⁾	3,260	3,328	3,147	3,351	3,305	3,260	3,305
radius in mm	144	147	139	148	146	144	146
Cat. No.	blood- / urine vessels			tubes with screw cap			



Adapter

boring Ø x L in mm	17.5x81	17.5x81	17.5x74	17x100	30x98	17.5x81	30x98
vessels per rotor	16	16	12	16	4	16	4
Cat. No.	1482A	1482A⁴⁾	1487	1483A	1484	1482A	1484⁴⁾

2) Please note that the RCF values indicated refer only to rotor performance. The max. permissible RCF of tubes used should be verified with the individual manufacturers. The max. RCF for glass tubes annotated with footnote 2) is 4,000.
 4) Please remove the spacer.

— SWING-OUT ROTOR, 4-PLACE | 1554



Rotor

max. RPM max. RCF	4,500 min ⁻¹ 3,260
max. capacity	8 x 50 ml
run-up run-down, braked in sec	28 31
angle max. noise level	90° 58 dB (A)
temperature in °C ¹⁾	-8

Cat. No. 1554



Bucket

Cat. No. 1563



Vessels

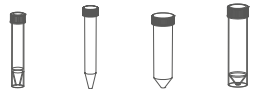

capacity in ml	12	15	50	50
Ø x L in mm	17x100	17x120	29x115	29x115
max. RCF ²⁾	3,260	3,260	3,260	3,260
radius in mm	144	144	144	144

Cat. No. tubes with screw cap

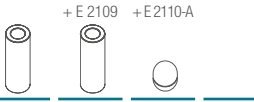

Adapter

boring Ø x L in mm	17x87	17.5x74	30x87	30x87
vessels per rotor	8	8	8	8

Cat. No. 1592 1592 - -



SWING-OUT ROTOR, 4-PLACE | 1494



Rotor

max. RPM max. RCF	5.000 min ⁻¹ 4.193
max. capacity	4 x 100 ml
run-up run-down, braked in sec	30 32
angle max. noise level	90° 56 dB (A)
temperature in °C ¹⁾	-10
Cat. No.	1494



Bucket

Cat. No.	1425
-----------------	-------------



Vessels

capacity in ml	1,5	2,0	1	3	5	6	7	9	15	25	50	100	1-8
Ø x L in mm	11 x 38	11 x 38	6 x 45	10 x 60	12 x 75	12 x 82	12 x 100	14 x 100	17 x 100	24 x 100	34 x 100	44 x 100	simple / multiple
max. RCF ²⁾	3,885	3,885	3,969	3,913	3,913	3,913	3,913	3,913	3,913	3,913	3,913	3,801	2,739
radius in mm	139	139	142	140	140	140	140	140	140	140	140	136	98
Cat. No.	microliter tubes		Rhesus	tubes²⁾									cyto chambers



Adapter

boring Ø x L in mm	11.5 x 38	11.5 x 38	6.5 x 34	10.5 x 40	13.4 x 50	12.7 x 60	12.7 x 60	17.5 x 84	17.5 x 84	25.5 x 84	35.5 x 84	45.5 x 86	-
vessels per rotor	36	36	144	56	28	48	48	28	28	8	4	4	4
Cat. No.	1444	1444	1432	1433	1438	1434	1434	1431	1431	1435	1436	1437	1452

Vessels

capacity in ml	2.6-3.4	2.7-3	4-5.5	4.5-5	4.9	7.5-8.5	9-10	1.6-5	4-7	4-7	8.5-10	15	50	50
Ø x L in mm	13 x 65	11 x 66	15 x 75	11 x 92	13 x 90	15 x 92	16 x 92	13 x 75	13 x 100	16 x 75	16 x 100	17 x 120	29 x 115	19 x 115
max. RCF ²⁾	3,913	3,913	3,913	3,913	3,913	3,913	3,913	3,913	3,913	3,913	3,913	4,081	4,081	4,081
radius in mm	140	140	140	140	140	140	140	140	140	140	140	146	146	146
Cat. No.	blood collection / urine vessels											tubes with screw cap		



Adapter

boring Ø x L in mm	13.4 x 50	13.4 x 50	16.5 x 50	13.4 x 50	13.4 x 50	16.5 x 50	17 x 45	13.4 x 50	13.4 x 50	16.5 x 50	16.5 x 50	17 x 90	30 x 90	30 x 90
vessels per rotor	28	28	28	28	28	28	16	28	28	28	28	4	4	4
Cat. No.	1438	1438	1441	1438	1438	1441	1439	1438	1438	1441	1441	1442	1443	1737

1) For cooled versions: Lowest temperature achievable with precooling and max. speed.
 2) Please note that the RCF values indicated refer only to rotor performance. The max. permissible RCF of tubes used should be verified with the individual manufacturers. The max. RCF for glass tubes annotated with footnote 2) is 4,000.

SWING-OUT ROTOR, 4-PLACE | 1494



Rotor

max. RPM max. RCF	5,000 min ⁻¹ 4,109
max. capacity	4 x 50 ml
run-up run-down, braked in sec	30 32
angle max. noise level	90° 54 dB (A)
temperature in °C ¹⁾	-10
Cat. No.	1494

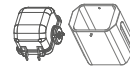

Bucket

Lid	1421
Cat. No.	1427



Vessels

capacity in ml	1.5	2.0	1	3	5	6	7	9	15	25	50	1.1-1.4	2.6-3.4	2.7-3	4-5.5	
Ø x L in mm	11 x 38	11 x 38	6 x 45	10 x 60	12 x 75	12 x 82	12 x 100	14 x 100	17 x 100	24 x 100	34 x 100	8 x 66	13 x 65	11 x 66	15 x 75	
max. RCF ²⁾	4,109	4,109	4,081	4,053	4,025	4,053	3,941	3,941	3,941	3,941	3,941	4,109	4,025	4,053	4,109	
radius in mm	147	147	146	145	144	145	141	141	141	141	141	147	144	145	147	
Cat. No.	microliter tubes		Rhesus	tubes 2)									blood collection / urine vessels			



Adapter

boring Ø x L in mm	11.5 x 38	11.5 x 38	6.5 x 34	10.5 x 40	13.4 x 58	12.5 x 44	12.4 x 87	15 x 73	17.8 x 87	25.5 x 87	35.5 x 87	9 x 41	13.4 x 58	12.5 x 44	15.6 x 41	
vessels per rotor	36	36	120	48	32	48	48	24	24	8	4	48	32	48	20	
Cat. No.	5277	5277	1357	1327	1732	5229	5230	5237	5231	5232	5233	5278	1732	5229	5279	

Vessels

capacity in ml	4.5 - 5	4.9	7.5 - 8.5	9 - 10	1.6 - 5	4 - 7	4 - 7	8.5 - 10	15	50	25	30	50	
Ø x L in mm	11 x 92	13 x 90	15 x 92	16 x 92	13 x 75	13 x 100	16 x 75	16 x 100	17 x 120	29 x 115	19 x 115	25 x 110	25 x 115	
max. RCF ²⁾	3,941	4,025	4,105	3,969	4,025	4,025	3,969	3,941	4,165	4,053	3,565	4,025	4,053	
radius in mm	141	144	147	142	144	144	142	141	145	145	142	144	145	
Cat. No.	blood collection / urine vessels								tubes with screw cap					



Adapter

boring Ø x L in mm	12.4 x 87	13.4 x 58	15.6 x 41	17 x 66	13.4 x 58	13.4 x 58	17 x 66	17.8 x 87	17 x 90	30 x 90	25.5 x 72	25.5 x 85	35.5 x 87	
vessels per rotor	48	32	20	20	32	32	20	24	4	4	8	4	4	
Cat. No.	5230	1732	5279	5271 4)	1732	1732	5271 4)	5231	5275	5276	1731	5272	5233 4)	

1) For cooled versions: Lowest temperature achievable with precooling and max. speed.
 2) Please note that the RCF values indicated refer only to rotor performance. The max. permissible RCF of tubes used should be verified with the individual manufacturers. The max. RCF for glass tubes annotated with footnote 2) is 4,000.
 3.1) When using these tubes, carrier 1427 cannot be closed with lid 1421.

SWING-OUT ROTOR, 4-PLACE | 1494



Rotor	
max. RPM max. RCF	5.000 min ⁻¹ 4.193
max. capacity	4 x 100 ml
run-up run-down, braked in sec	30 32
angle max. noise level	90° 58 dB (A)
temperature in °C ¹⁾	-10
Cat. No.	1494



Bucket	
Lid bioseal ⁵⁾	1492
Cat. No.	1495

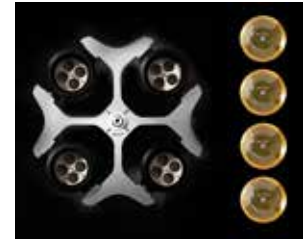

Vessels															
capacity in ml		0.5	1.5	2.0	1	3	5	6	7	9	15	25	50	94	100
Ø x L in mm		10.7x36	11x38	11x38	6 x 45	10 x 60	12x75	12x82	12x100	14x100	17x100	24x100	34x100	38x102	44x100
max. RCF ²⁾		3,745	3,857	3,857	4,081	4,137	4,025	4,025	4,025	3,997	3,997	3,829	3,801	4,109	4,025
radius in mm		134	138	138	146	148	144	144	144	143	143	137	136	147	144
Cat. No.		Pediatric	microliter tubes			Rhesus	tubes²⁾								

Adapter																Spacer
boring Ø x L in mm		11.2x38	11.2x38	11.2x38	6.5x34	10.5x40	13.4x48	13.4x48	13.4x48	17.6x91	17.6x91	25.2x87	35.2x87	35.5x92	45.6x98	
vessels per rotor		20	20	20	108	36	20	20	20	16	16	4	4	4	4	
Cat. No.		1351	1351	1351	1339	1343	1383	1383	1383	1329	1329	1330	1331	1396	0761	

Vessels															
capacity in ml		1.1-1.4	2.7-5	2.7-5	2.6-4.9	2.6-4.9	4-8.5	4-8.5	9-10	10	1.6-5	1.6-5	4-10	4-10	
Ø x L in mm		8 x 66	11x66	11x92	13x65	13x90	15x75	15x92	16 x 92	15 x 102	13x75	13 x 100	16 x 75	16 x 100	
max. RCF ²⁾		4,053	4,025	4,025	4,025	4,025	4,053	4,053	3,997	4,193	4,025	4,025	4,025	4,025	
radius in mm		145	144	144	144	144	145	145	143	150	144	144	144	144	
Cat. No.		blood collection / urine vessels													

Adapter														
boring Ø x L in mm		9x47	13.4x48	13.4x48	13.4x48	13.4x48	15.6x47	15.6x47	17.6x91	17.6x91	13.4x48	13.4x48	16.5x56	16.5x56
vessels per rotor		28	20	20	20	20	16	16	16	16	20	20	16	16
Cat. No.		1457	1383	1383	1383	1383	1459	1459	1329	1329⁴⁾	1383	1383	1348	1348

Vessels															chrome bath tube
capacity in ml		15	30	50	12	25	50	10	30	50	85	30	30		
Ø x L in mm		17 x 120	25 x 110	29 x 115	17 x 100	25 x 90	29 x 115	16 x 80	26 x 95	29x107	38x106	44x105	44x105		
max. RCF ²⁾		4,193	4,193	4,193	4,193	3,689	4,193	4,025	3,857	4,137	4,109	3,997	3,997		
radius in mm		150	150	150	150	132	150	144	138	148	147	143	143		
Cat. No.		tubes with screw cap											0534⁶⁾		

Adapter													Spacer
boring Ø x L in mm		17x90	26x80	30x90	17x80	26x72	29.5x80	16.5x56	26x83	29x93	38.5x92	45.9x98	
vessels per rotor		4	4	4	4	4	4	16	4	4	4	4	
Cat. No.		1347	1365	1384	6311	1363	6318	1348	4417	4416	1396	0765	

1) For cooled versions: Lowest temperature achievable with precooling and max. speed.
 2) Please note that the RCF values indicated refer only to rotor performance. The max. permissible RCF of tubes used should be verified with the individual manufacturers. The max. RCF for glass tubes annotated with footnote 2) is 4,000.
 3) When using these tubes, bucket 1495 cannot be closed with lid 1492.
 4) Tested by the TÜV in conformity with DIN EN 61010, section 2 - 020.
 6) A rubber stopper for closing the tube for agitating or mixing is available under Cat. No. 0535. The tube may not be centrifuged with the stopper.

SWING-OUT ROTOR, 4-PLACE | 1624



Rotor

max. RPM max. RCF	4,000 min ⁻¹ 2,665
max. capacity	4 x 50 ml
run-up run-down, braked in sec	20 25
angle	90°
Cat. No.	1624



Vessels

capacity in ml	5	5	6	7	9	9	15	15	20	25	45	50	1-8
Ø x L in mm	12x75	12x75	12x82	12x100	14x100	14x100	17x100	17x100	21x100	24x100	31x100	34x100	simple / multiple
max. RCF ²⁾	2,057	2,164	2,308	2,308	2,308	2,415	2,308	2,415	2,361	2,451	2,361	2,451	1,646
radius in mm	115	121	129	129	129	135	129	137	132	137	132	137	92
temperature in °C ¹⁾	-17	-17	-17	-17	-17	-15	-17	-15	-15	-15	-15	-15	-16
Cat. No.	tubes²⁾												cyto chambers



Carrier

boring Ø x L in mm	12.5x64.4	13.5x65	12.5x71.5	12.5x71.5	14.6x74	14.6x78	17.6x74	17.6x78	21.5x74	26x78	32x74	35x78	-	-
vessels per rotor	16	68	16	16	20	40	16	28	8	8	4	4	4	4
Cat. No.	1369-91	1372	1369-92	1369-92	1370	1741	1369	1742	1346	1745	1345	1746	1660	

Vessels

capacity in ml	1.1-1.4	2.6-3.4	4.5-5	4.9	1.6-5	4-7	1.6-5	4-7	4-7	4-7	4-7	8.5-10	30
Ø x L in mm	8 x 66	13x65	15x75	13x90	13x75	16x75	13x75	16x75	13x100	13x100	13x100	16x100	26 x 95
max. RCF ²⁾	2,415	2,325	2,325	2,451	2,129	2,361	2,325	2,325	2,361	2,361	2,451	2,361	2,451
radius in mm	135	130	130	137	119	132	130	130	132	132	137	132	137
temperature in °C ¹⁾	-15	-15	-15	-15	-15	-15	-15	-15	-15	-15	-15	-17	-15
Cat. No.	blood collection / urine vessels												0545



Carrier

boring Ø x L in mm	14.6x78	17.6x78	17.6x78	14.6x78	14.6x78	17.6x74	17.6x78	17.6x78	17.6x74	14.6x74	13.5x78	17.6x74	26x78
vessels per rotor	40	28	28	40	40	16	28	28	16	20	28	16	8
Cat. No.	1741	1742	1742	1741	1741	1369⁴⁾	1742	1742	1369⁴⁾	1370⁴⁾	1739	1369⁴⁾	1745

1) For cooled versions: Lowest temperature achievable with precooling and max. speed.
 2) Please note that the RCF values indicated refer only to rotor performance. The max. permissible RCF of tubes used should be verified with the individual manufacturers. The max. RCF for glass tubes annotated with footnote 2) is 4,000.
 4) Please remove spacer.
 16) Packed in units of 10 pieces.
 20) This combination permits no Vacutainers made of glass.

— SWING-OUT ROTOR, 4-PLACE | 1624



Rotor

max. RPM max. RCF	4,000 min ⁻¹ 1,968
max. capacity	48 x 4 ml
run-up run-down, braked in sec	22 25
angle max. noise level	90° 48 dB (A)
temperature in °C	-15
Cat. No.	1624



Bucket

Cat. No.	1366
-----------------	-------------



Vessels



capacity in ml	1.5	2.0	1	3	4
Ø x L in mm	11 x 38	11 x 38	6 x 45	10 x 60	12 x 60
max. RCF ²⁾	1,968	1,968	1,950	1,932	1,932
radius in mm	110	110	109	108	108
Cat. No.	microliter tubes	Rhesus	tubes³⁾		



Adapter

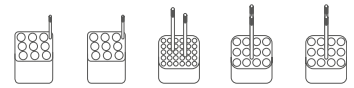

boring Ø x L in mm	11.5x38	11.5x38	6.5x23	10.5x23	12.5x44
vessels per rotor	36	36	120	48	48
Cat. No.	5277	5277	1357	1327	1326

— SWING-OUT ROTOR, 4-PLACE | 1624



Rotor

max. RPM max. RCF ²⁾	4,000 min ⁻¹ 2,665
max. capacity	4 x 100 ml
run-up run-down, braked in sec	20 25
angle max. noise level	90° 58 dB (A)
temperature in °C	-15
Cat. No.	1624



Bucket

Lid bioseal ⁵⁾	1492
Cat. No.	1481



Vessels

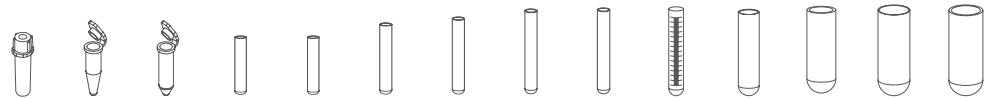

capacity in ml	0.5	1.5	2.0	1	3	5	6	7	9	15	25	50	94	100
Ø x L in mm	10,7x36	11x38	11x38	6x45	10x60	12x75	12x82	12x100	14x100	17x100	24x100	34x100	38x102	44x100
max. RCF ²⁾	2,379	2,451	2,451	2,594	2,630	2,558	2,558	2,558	2,540	2,540	2,433	2,415	2,612	2,558
radius in mm	133	137	137	145	147	143	143	143	142	142	136	135	146	143
Cat. No.	Pediatric	microliter tubes		Rhesus	tubes³⁾									



Adapter

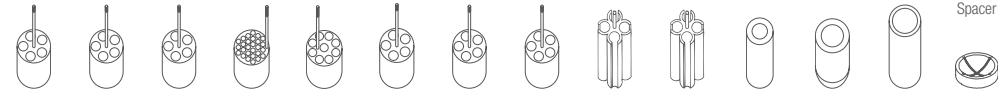

boring Ø x L in mm	11.2x38	11.2x38	11.2x38	6.5x34	10.5x43	13.4x48	13.4x48	13.4x48	17.6x91	17.6x91	25.2x87	35.2x87	38.5x92	45.9x98
vessels per rotor	20	20	20	108	36	20	20	20	16	16	4	4	4	4
Cat. No.	1351	1351	1351	1339	1343	1383	1383	1383	1329	1329	1330	1331	1396	0761

1) For cooled versions: Lowest temperature achievable with precooling and max. speed.
 2) Please note that the RCF values indicated refer only to rotor performance. The max. permissible RCF of tubes used should be verified with the individual manufacturers. The max. RCF for glass tubes annotated with footnote 2) is 4,000.
 5) Tested by the TÜV in conformity with DIN EN 61010. section 2 - 020.

SWING-OUT ROTOR, 4-PLACE | 1624



Rotor

max. RPM max. RCF	4,000 min ⁻¹ 2,665
max. capacity	4 x 100 ml
run-up run-down, braked in sec	20 25
angle max. noise level	90° 58 dB (A)
temperature in °C	-15
Cat. No.	1624



Bucket

Lid bioseal ⁵⁾	1492
Cat. No.	1481



Vessels

capacity in ml	1.1-1.4	2.7-5	2.7-5	2.6-4.9	2.6-4.9	4-8.5	4-8.5	9-10	10	1.6-7	1.6-7	4-10	4-10
Ø x L in mm	8 x 66	11 x 66	11 x 92	13 x 65	13 x 90	15 x 75	15 x 92	16 x 92	15 x 102	13 x 75	13 x 100	16 x 75	16 x 100
max. RCF ²⁾	2,576	2,558	2,558	2,558	2,558	2,576	2,576	2,540	2,665	2,558	2,558	2,522	2,522
radius in mm	144	143	143	143	143	144	144	142	149	143	143	141	141
Cat. No.	blood collection / urine vessels												



Adapter

boring Ø x L in mm	9x47	13.4x48	13.4x48	13.4x48	13.4x48	15.6x47	15.6x47	17.6x91	17.6x91	13.4x48	13.4x48	16.5x56	16.5x56
vessels per rotor	28	20	20	20	20	16	16	16	16	20	20	16	16
Cat. No.	1457	1383	1383	1383	1383	1459	1459	1329	1329⁴⁾	1383	1383	1348	1348

Vessels

capacity in ml	5	15	50	12	25	30	50	10	30	50	85	chrome bath tube	30
Ø x L in mm	17x59	17x120	29x115	17x100	25x90	25x110	29x115	16x80	26x95	29x107	38x106	44x105	44x105
max. RCF ²⁾	2,665	2,665	2,665	2,665	2,343	2,665	2,665	2,522	2,451	2,630	2,612	2,540	2,540
radius in mm	149	149	149	149	131	149	149	141	137	147	146	142	142
Cat. No.	-	tubes with screw cap										0534⁶⁾	



Adapter

boring Ø x L in mm	17x45	17x90	30x90	17x80	26x72	26x80	29.5x80	16.5x56	26x83	29x93	38.5x92	Spacer	45.9x98
vessels per rotor	12	4	4	4	4	4	4	16	4	4	4	Spacer	4
Cat. No.	6341	1347	1384	6311	1363	1365	6318	1348	4417	4416	1396	Spacer	0765

2) Please note that the RCF values indicated refer only to rotor performance. The max. permissible RCF of tubes used should be verified with the individual manufacturers.

The max. RCF for glass tubes annotated with footnote 2) is 4,000.

5) Tested by the TÜV in conformity with DIN EN 61010, section 2 - 020.

6) A rubber stopper for closing the tube for agitating or mixing is available under Cat. No. 0535. The tube may not be centrifuged with the stopper.

SWING-OUT ROTOR, 4-PLACE | 1324



Rotor	
max. RPM max. RCF	4,500 min ⁻¹ 3,328
max. capacity	4 x 100 ml
run-up run-down, braked in sec	27 30
angle max. noise level	90° 58 dB (A)
temperature in °C	-6
Cat. No.	1324



Bucket	
Lid bioseal ⁵⁾	1492
Cat. No.	1490



Vessels															
capacity in ml	0,5	1,5	2,0	1	3	4	5	6	7	9	15	25	50	94	100
Ø x L in mm	10.7x36	11x38	11x38	6x45	10x60	10x88	12x75	12x82	12x100	14x100	17x100	24x100	34x100	38x102	44x100
max. RCF ²⁾	2,966	3,056	3,056	3,237	3,283	3,283	3,192	3,192	3,192	3,170	3,170	3,034	3,011	3,260	3,192
radius in mm	131	135	135	143	145	145	141	141	141	140	140	134	133	144	141
Cat. No.	Pediatric	microliter tubes		Rhesus	tubes²⁾										

Adapter																	Spacer
boring Ø x L in mm	11.2x38	11.2x38	11.2x38	6.5x34	10.5x43	10.5x43	13.4x48	13.4x48	13.4x48	17.6x91	17.6x91	25.2x87	35.2x87	38.5x92	45.9x100.5		
vessels per rotor	20	20	20	108	36	36	20	20	20	16	16	4	4	4	4		
Cat. No.	1351	1351	1351	1339	1343	1343	1383	1383	1383	1329	1329	1330	1331	1396	0761		

Vessels															
capacity in ml	1.1-1.4	2.6-3.4	4.9	2.7-3	4.5-5	4-5.5	7.5-8.5	9-10	10	1.6-5	4-7	4-7	8.5-10	5	15
Ø x L in mm	8 x 66	13x65	13x90	11x66	11x92	15x75	15x92	16x92	15x102	13x75	13x100	16x75	16x100	17x59	17x120
max. RCF ²⁾	3,215	3,192	3,192	3,192	3,192	3,215	3,215	3,170	3,328	3,192	3,192	3,147	3,147	3,328	3,328
radius in mm	142	141	141	141	141	142	142	140	147	141	141	139	139	147	147
Cat. No.	blood collection / urine vessels													-	-

Adapter															
boring Ø x L in mm	9x47	13.4x48	13.4x48	13.4x48	13.4x48	15.6x47	15.6x47	17.6x91	17.6x91	13.4x48	13.4x48	16.5x56	16.5x56	17x45	17x90
vessels per rotor	28	20	20	20	20	16	16	16	16	20	20	16	16	12	4
Cat. No.	1457	1383	1383	1383	1383	1459	1459	1329	1329⁴⁾	1383	1383	1348	1348	6341	1347

Vessels														chrome bath tube
Kapazität in ml	15	30	50	12	25	30	50	10	30	50	85	30		
Ø x L in mm	17x120	25 x 110	29 x 115	17 x 100	25 x 90	25 x 110	29 x 115	16 x 80	26 x 95	29x107	38x106	44x105		
max. RCF ²⁾	3,328	3,328	3,328	3,328	2,920	3,328	3,328	3,147	3,056	3,283	3,260	3,170		
radius in mm	147	147	147	147	129	147	147	139	135	145	144	140		
Cat. No.	tubes with screw cap												0534⁶⁾	

Adapter													Spacer
boring Ø x L in mm	17x107	26x80	30x90	17x80	26x72	26x80	29.5x80	16.5x56	26x83	29x93	38.5x92	45.9x100.5	
vessels per rotor	12	4	4	4	4	4	4	16	4	4	4	4	
Cat. No.	1356	1365	1384	6311	1363	1365	6318	1348	4417	4416	1396	0765	

3) When using these tubes, carrier 1490 cannot be closed with lid 1492.

5) Tested by the TÜV in conformity with DIN EN 61010, section 2 - 020.

6) A rubber stopper for closing the tube for agitating or mixing is available under Cat. No. 0535. The tube may not be centrifuged with the stopper.

SWING-OUT ROTOR, 4-PLACE | 1324

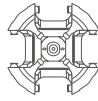

Rotor

max. RPM max. RCF	4,500 min ⁻¹ 3,305
max. capacity	4 x 50 ml
run-up run-down, braked in sec	27 30
angle max. noise level	90° 54 dB (A)
temperature in °C	-6
Cat. No.	1324



Bucket

Cat. No.	1398
-----------------	-------------



Vessels

capacity in ml	5	6	7	9	12	15	2.6-3.4	2.7-3	4-5.5	4.5-5	4.9	9-10	10	1.6-5	4-7
Ø x L in mm	12x75	12x82	12x100	14x100	17x102	17x100	13x65	11x66	15x75	11x92	13x90	16x92	15x102	13x75	13x100
max. RCF ²⁾	3,147	3,147	3,147	3,192	3,102	3,192	3,147	3,147	2,875	3,147	3,147	3,192	3,192	3,147	3,147
radius in mm	139	139	139	141	137	141	139	139	127	139	139	141	141	139	139
Cat. No.	1324						1324								



Adapter

boring Ø x L in mm	13.4x57.5	13.4x57.5	13.4x57.5	17.5x81	17.5x74	17.5x81	13.4x57.5	13.4x57.5	17.5x81	13.4x57.5	13.4x57.5	17.5x81	17.5x81	13.4x57.5	13.4x57.5
vessels per rotor	20	20	20	16	12	16	20	20	16	20	20	16	16	20	20
Cat. No.	1486	1486	1486	1482A	1487	1482A	1486	1486	1482A	1486	1486	1482A	1482A	1486	1486

Vessels

capacity in ml	4-7	8.5-10	15	50	12	50
Ø x L in mm	16x75	16x100	17 x 120	29 x 115	17 x 100	29 x 115
max. RCF ²⁾	3,034	3,034	3,305	3,260	3,192	3,260
radius in mm	134	134	146	144	141	144
Cat. No.	1482A		1482A			



Adapter

boring Ø x L in mm	17.5x81	17.5x81	17x100	30x98	17.5x81	30x98
vessels per rotor	16	16	16	4	16	4
Cat. No.	1482A	1482A	1483A	1484	1482A	1484⁴⁾

1) For cooled versions: Lowest temperature achievable with precooling and max. speed.
 2) Please note that the RCF values indicated refer only to rotor performance. The max. permissible RCF of tubes used should be verified with the individual manufacturers. The max. RCF for glass tubes annotated with footnote 2) is 4,000.
 4) Please remove spacer.

SWING-OUT ROTOR, 8-PLACE | 1611



Rotor

max. RPM max. RCF	4,000 min ⁻¹ 2,415
max. capacity	8 x 15 ml
run-up run-down, braked in sec	20 20
angle max. noise level	90° 48 dB (A)
temperature in °C ¹⁾	-16
Cat. No.	1611



Vessels

capacity in ml	5	6	7	10	15	2.6 – 3.4	2.7 – 3	4 – 5.5	4.5 – 5	7.5 – 8.5	1.6 – 5	4 – 7	4 – 7	8.5 – 10
Ø x L in mm	12 x 75	12 x 82	12 x 100	13 x 100	17 x 100	13 x 65	11 x 66	15 x 75	11 x 92	15 x 92	13 x 75	13 x 100	16 x 75	16 x 100
max. RCF ²⁾	1,914	1,914	2,415	2,415	2,415	1,914	1,914	1,914	2,415	2,415	1,914	2,415	1,914	2,415
radius in mm	107	107	135	135	135	107	107	107	135	135	107	135	107	135
Cat. No.	tubes²⁾					blood collection / urine vessels								



Bucket

boring Ø x L in mm	13 x 53	13 x 53	13.2 x 81	13.2 x 81	17.5 x 81	13 x 53	13 x 53	17.5 x 53	13.2 x 81	17.5 x 81	13 x 53	13.2 x 81	17.5 x 53	17.5 x 81
vessels per rotor	8	8	8	8	8	8	8	8	8	8	8	8	8	8
Cat. No.	1131-A	1131-A	1643	1643	1644	1131-A	1131-A	1132-A	1643	1644	1131-A	1643	1132-A	1644

SWING-OUT ROTOR, 12-PLACE | 1628



Rotor

max. RPM max. RCF ²⁾	5,000 min ⁻¹ 4,193
max. capacity	12 x 15 ml
run-up run-down, braked in sec	16 16
angle max. noise level	55° / 60° / 80° 54 dB (A)
Cat. No.	1628



Vessels

capacity in ml	5	15	2.6 – 3.4	2.7 – 3	4 – 5.5	7.5 – 8.5	1.6 – 5	4 – 7	8.5 – 10
Ø x L in mm	12 x 75	17 x 100	13 x 65	11 x 66	15 x 75	15 x 92	13 x 75	16 x 75	16 x 100
max. RCF ²⁾	3,494	4,193	3,494	3,494	3,522	4,193	3,494	3,522	4,193
radius in mm	125	150	125	125	126	150	125	126	150
temperature in °C ¹⁾	-15	-10	-15	-15	-15	-10	-15	-15	-10
Cat. No.	tubes²⁾		blood collection / urine vessels						



Bucket

boring Ø x L in mm	13.2 x 53	17.5 x 79	13.2 x 53	13.2 x 53	17.5 x 53	17.5 x 79	13.2 x 53	17.5 x 53	17.5 x 79
vessels per rotor	12	12	12	12	12	12	12	12	12
Cat. No.	1127-A	1621	1127-A	1127-A	1122	1621	1127-A	1122	1621

1) For cooled versions: Lowest temperature achievable with precooling and max. speed.

2) Please note that the RCF values indicated refer only to rotor performance. The max. permissible RCF of tubes used should be verified with the individual manufacturers. The max. RCF for glass tubes annotated with footnote 2) is 4,000.

— SWING-OUT ROTOR, 8-PLACE | 1617



Rotor

max. RPM max. RCF	5,000 min ⁻¹ 3,857
max. capacity	8 x 50 ml
run-up run-down, braked in sec	20 19
angle max. noise level	45° 50 dB (A)
temperature in °C ¹⁾	-10

Cat. No. 1617

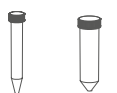

Vessels

capacity in ml	15	50
Ø x L in mm	17x120	29x115
max. RCF ²⁾	3,857	3,857
radius in mm	138	138

Cat. No. tubes with screw cap



Adapter

boring Ø x L in mm	17x84	30x94.5
vessels per rotor	8	8

Cat. No. 1462-A -

— SWING-OUT ROTOR, 6-PLACE | 1619



Rotor

max. RPM max. RCF	4,000 min ⁻¹ 2,701
max. capacity	6 x 50 ml
run-up run-down, braked in sec	20 22
angle max. noise level	90° 50 dB (A)
temperature in °C ¹⁾	-15

Cat. No. 1619

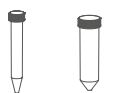

Vessels

capacity in ml	15	50
Ø x L in mm	17x120	29x115
max. RCF ²⁾	2,701	2,701
radius in mm	151	151

Cat. No. tubes with screw cap



Adapter

boring Ø x L in mm	17x84	30x87.5
vessels per rotor	6	6

Cat. No. 1462-A -

1) For cooled versions: Lowest temperature achievable with precooling and max. speed.
 2) Please note that the RCF values indicated refer only to rotor performance. The max. permissible RCF of tubes used should be verified with the individual manufacturers. The max. RCF for glass tubes annotated with footnote 2) is 4,000.

— SWING-OUT ROTOR, 2-PLACE | 1460

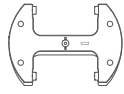

Rotor

max. RPM max. RCF	4,000 min ⁻¹ 2,218
max. capacity	10 plates
run-up run-down, braked in sec	40 45
angle max. noise level	90° 55 dB (A)
temperature in °C ¹⁾	-6
Cat. No.	1460



Vessels

capacity in ml	-	-	-	-	-	-	-	-	0,2
W x D x H in mm	128x86x15	128x86x17.5	128x86x22	128 x 86 x 44.5	128 x 86 x 46	128 x 86 x 83	84 x 59 x 11	124 x 82 x 20	-
max. RCF ²⁾	2,218	2,218	2,218	2,218	2,218	2,218	2,218	2,218	2,218
radius in mm	124	124	124	124	124	124	124	124	124
Cat. No.	MTP	MTP	CP	DWP	MS	QP	Microtest plates	PCR plate, 96 wells	PCR strips



Bucket

boring Ø x L in mm	-	-	-	-	-	-	-	-	-
vessels per rotor	10	8	6	2	2	2	4	2	24 x 8
Cat. No.	1453-A	1453-A	1453-A	1453-A	1453-A	1453-A	1453-A	1453-A + 1485	1453-A + 1485

— SWING-OUT ROTOR, 24-PLACE | 1555



Rotor

max. RPM max. RCF	13,000 min ⁻¹ 18,327
max. capacity	24 x 2 ml
run-up run-down, braked in sec	36 31
angle	90°
temperature in °C ¹⁾	3
Cat. No.	1555

Lid bioseal[®], phenol-resistant

Cat. No.



INCLUSIVE



Vessels

capacity in ml	0.2	0.4	0.5	0.8	1.5	2
Ø x L in mm	6x18	6x45	8x30	8x45	11x38	11x38
max. RCF ²⁾	18,327	18,327	18,327	18,327	18,327	18,327
radius in mm	97	97	97	97	97	97
Cat. No.	microliter tubes					



Adapter

boring Ø x L in mm	6x40	6x40	8x40	8x40	-	11.5x38.5
vessels per rotor	24	24	24	24	24	24
Cat. No.	2024	2024	2023	2023	2031⁷⁾	-

1) For cooled versions: Lowest temperature achievable with precooling and max. speed.
 2) Please note that the RCF values indicated refer only to rotor performance. The max. permissible RCF of tubes used should be verified with the individual manufacturers. The max. RCF for glass tubes annotated with footnote 2) is 4,000.
 5) Tested by TÜV in conformity with DIN EN 61010, section 2 - 020.

— ANGLE ROTOR, 24-PLACE | 1552



Rotor

max. RPM max. RCF	16,000 min ⁻¹ 24,900
max. capacity	24 x 2 ml
run-up run-down, braked in sec	30 29
angle max. noise level	50° 58 dB (A)
temperature in °C ¹⁾	2

Cat. No.	1552
-----------------	-------------

Lid bioseal⁵⁾, phenol-resistant

Cat. No.	INCLUSIVE
-----------------	------------------

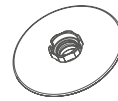

Vessels

capacity in ml	0.2	0.4	0.5	0.8	1.5	2	0.5
Ø x L in mm	6x18	6x45	8x30	8x45	11x38	11x38	10,7x36
max. RCF ²⁾	24,900	24,900	24,900	24,900	24,900	24,900	23,755
radius in mm	87	87	87	87	87	87	83

Cat. No.	microliter tubes						Pediatric
-----------------	-------------------------	--	--	--	--	--	------------------



Adapter

boring Ø x L in mm	6x40	6x40	8x40	8x40	10.2x19	11.2x42.6	11.2x39
vessels per rotor	24	24	24	24	24	24	12

Cat. No.	2024	2024	2023	2023	2031⁷⁾	-	0788¹⁷⁾
-----------------	-------------	-------------	-------------	-------------	--------------------------	----------	---------------------------

— ANGLE ROTOR, 30-PLACE | 1553



Rotor

max. RPM max. RCF	14,150 min ⁻¹ 21,713
max. capacity	30 x 2 ml
run-up run-down, braked in sec	35 32
angle	45°
temperature in °C ¹⁾	-1

Cat. No.	1553
-----------------	-------------

Lid bioseal⁵⁾, phenol-resistant

Cat. No.	INCLUSIVE
-----------------	------------------



Vessels

capacity in ml	0.2	0.4	0.5	0.8	1.5	2	0.5
Ø x L in mm	6x18	6x45	8x30	8x45	11x38	11x38	10,7x36
max. RCF ²⁾	21,713	21,713	21,713	21,713	21,713	21,713	20,818
radius in mm	97	97	97	97	97	97	93

Cat. No.	microliter tubes						Pediatric
-----------------	-------------------------	--	--	--	--	--	------------------



Adapter

boring Ø x L in mm	6x40	6x40	8x40	8x40	10.2x19	11.2x40.9	11.2x39
vessels per rotor	30	30	30	30	30	30	15

Cat. No.	2024	2024	2023	2023	2031⁷⁾	-	0788¹⁷⁾
-----------------	-------------	-------------	-------------	-------------	--------------------------	----------	---------------------------

1) For cooled versions: Lowest temperature achievable with precooling and max. speed.
 2) Please note that the RCF values indicated refer only to rotor performance. The max. permissible RCF of tubes used should be verified with the individual manufacturers. The max. RCF for glass tubes annotated with footnote 2) is 4,000.
 5) Tested by TÜV in conformity with DIN EN 61010, section 2 - 020.
 17) Packed in units of 15 pieces.

— ANGLE ROTOR, 8-PLACE | 1551



Rotor

max. RPM max. RCF	13,000 min ⁻¹ 13,604	
max. capacity	8 x PCR-Strips	
run-up run-down, braked in sec	36 31	
angle max. noise level	45° 58 dB (A)	
temperature in °C ¹⁾	-4	
Cat. No.	1551	

Lid bioseal[®], phenol-resistant



Cat. No.

INCLUSIVE



Vessels

capacity in ml	0.2	0.2
Ø x L in mm	6x18	-
max. RCF ²⁾	13,604	13,604
radius in mm	72	72
Cat. No.	-	PCR-Strips

— ANGLE ROTOR, 18-PLACE | 1627



Rotor

max. RPM max. RCF	14,150 min ⁻¹ 22,161	
max. capacity	18x5 ml	
run-up run-down, braked in sec	35 32	
angle	45°	
temperature in °C ¹⁾	2	
Cat. No.	1627	

Lid bioseal[®], phenol-resistant



Cat. No.

INCLUSIVE



Vessels

capacity in ml	5
Ø x L in mm	17x59
max. RCF ²⁾	22,161
radius in mm	99
Cat. No.	-

1) For cooled versions: Lowest temperature achievable with precooling and max. speed.
 2) Please note that the RCF values indicated refer only to rotor performance. The max. permissible RCF of tubes used should be verified with the individual manufacturers. The max. RCF for glass tubes annotated with footnote 2) is 4,000.
 5) Tested by TÜV in conformity with DIN EN 61010, section 2 - 020.

— ANGLE ROTOR, 6-PLACE | 1556



Rotor

max. RPM max. RCF	9,000 min ⁻¹ 10,595
max. capacity	6x94 ml
run-up run-down, braked in sec	36 32
angle max. noise level	35° 60 dB (A)
temperature in °C ¹⁾	0

Cat. No.	1556
-----------------	-------------

Lid bioseal[®], phenol-resistant

Cat. No.	INCLUSIVE
-----------------	------------------



Vessels

capacity in ml	1,5	2	15	50	50	85	7.5–8.5	9–10	10	8.5–10	15	50	10	30	50
∅ x L in mm	11 x 38	11 x 38	17 x 100	35 x 105	34 x 100	38 x 101	15 x 92	16 x 92	15 x 102	16 x 100	17 x 120	29 x 115	16 x 80	26 x 95	29 x 107
max. RCF ²⁾	10,324	10,324	10,052	10,414	10,414	10,595	10,052	10,052	10,052	10,052	10,052	10,052	10,414	9,690	10,142
radius in mm	114	114	111	115	115	117	111	111	111	111	111	111	115	107	112

Cat. No.	microliter tubes	tubes²⁾					blood collection / urine vessels					tubes with screw cap				
-----------------	-------------------------	---------------------------	--	--	--	--	---	--	--	--	--	-----------------------------	--	--	--	--



Adapter

boring ∅ x L in mm	11.4 x 39	11.4 x 39	17.5 x 78	35 x 89	35 x 89	-	17.5 x 78	17.5 x 78	17.5 x 78	17.5 x 78	17 x 106	29.8 x 97	16.5 x 72	26 x 85	29 x 92
vessels per rotor	24	24	6	6	6	6	6	6	6	6	6	6	12	6	6

Cat. No.	1449	1449	1478	1463	1463	-	1478	1478	1478	1478	1466	1454	1477	1447	1446
-----------------	-------------	-------------	-------------	-------------	-------------	----------	-------------	-------------	-------------	-------------	-------------	-------------	-------------	-------------	-------------

Vessels

capacity in ml	85	94
∅ x L in mm	38 x 106	38 x 102
max. RCF ²⁾	10,595	10,595
radius in mm	117	117

Cat. No.	tubes with screw cap	
-----------------	-----------------------------	--



Adapter

boring ∅ x L in mm	-	-
vessels per rotor	6	6

Cat. No.	-	-
-----------------	----------	----------

1) For cooled versions: Lowest temperature achievable with precooling and max. speed.
 2) Please note that the RCF values indicated refer only to rotor performance. The max. permissible RCF of tubes used should be verified with the individual manufacturers. The max. RCF for glass tubes annotated with footnote 2) is 4,000.

— ANGLE ROTOR, 12-PLACE | 1613



Rotor

max. RPM max. RCF	6,000 min ⁻¹ 4,146
max. capacity	12 x 15 ml
run-up run-down, braked in sec	15 15
angle max. noise level	35° 50 dB (A)
temperature in °C ¹⁾	-16
Cat. No.	1613



Vessels

capacity in ml	0.5	1.5	2.0	4	5	6	15	1.1 – 1.4	2.6 – 3.4	2.7 – 3	4.5 – 5	4.9	7.5 – 8.5	9 – 10	10
Ø x L in mm	10.7 x 36	11 x 38	11 x 38	10 x 88	12 x 75	12 x 82	17 x 100	8 x 66	13 x 65	11 x 66	11 x 92	13 x 90	15 x 92	16 x 92	15 x 102
max. RCF ²⁾	2,777	2,737	2,737	3,502	3,300	3,300	4,146	3,300	3,300	3,300	4,146	4,146	4,146	4,146	4,146
radius in mm	69	68	68	87	82	82	103	82	82	82	103	103	103	103	103
Cat. No.	Pediatric	microliter tubes			tubes²⁾			blood collection / urine vessels							



Adapter

boring Ø x L in mm	11 x 35	11 x 35	11 x 35	11.5x67.5	13.5 x 60	13.5 x 60	17.7 x 88	13.5 x 60	13.5 x 60	13.5 x 60	17.7 x 88	17.7 x 88	17.7 x 88	17.7 x 88	17.7 x 88
vessels per rotor	12	12	12	12	12	12	12	12	12	12	12	12	12	12	12
Cat. No.	2 x 1063-6 (6 pcs.)			6305	1054-A	1054-A	-	1054-A	1054-A	1054-A	-	-	-	-	-

Vessels

capacity in ml	1.6 – 5	4 – 7	8	8.5 – 10	5	15
Ø x L in mm	13 x 75	13 x 100	16 x 125	16 x 100	17 x 59	17 x 120
max. RCF ²⁾	3,300	4,146	4,146	4,146	3,180	4,146
radius in mm	82	103	103	103	79	103
Cat. No.	blood collection / urine vessels			-	-	-



Adapter

boring Ø x L in mm	13.5 x 60	13.5 x 79	17.7 x 88	17.7 x 88	17 x 25	17.7 x 88
vessels per rotor	12	12	6	12	12	6
Cat. No.	1054-A	1058	-	-	1064	-

1) For cooled versions: Lowest temperature achievable with precooling and max. speed.

2) Please note that the RCF values indicated refer only to rotor performance. The max. permissible RCF of tubes used should be verified with the individual manufacturers. The max. RCF for glass tubes annotated with footnote 2) is 4,000.

— ANGLE ROTOR, 12-PLACE | 1615

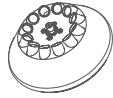

Rotor

max. RPM max. RCF	12,000 min ⁻¹ 16,582
max. capacity	12 x 15 ml
run-up run-down, braked in sec	40 40
angle max. noise level	35° 52 dB (A)
temperature in °C ¹⁾	-2
Cat. No.	1615



Vessels

capacity in ml	0.5	1.5	2.0	4	5	6	15	1.1 - 1.4	2.6 - 3.4	2.7 - 3	4.5 - 5	4.9	7.5 - 10	10
Ø x L in mm	10.7 x 36	11 x 38	11 x 38	10 x 88	12 x 75	12 x 82	17 x 100	8 x 66	13 x 65	11 x 66	11 x 92	13 x 90	15/16 x 92	15 x 102
max. RCF ²⁾	11,108	10,947	10,947	14,006	13,201	13,201	16,582	13,201	13,201	13,201	16,582	16,582	16,582	16,582
radius in mm	69	68	68	87	82	82	103	82	82	82	103	103	103	103
Cat. No.	Pediatric	microliter tubes			tubes²⁾			blood collection / urine vessels						



Adapter

boring Ø x L in mm	11 x 35	11 x 35	11 x 35	11.5 x 67.5	13.5 x 60	13.5 x 60	17.7 x 88	13.5 x 60	13.5 x 60	13.5 x 60	17.7 x 88	17.7 x 88	17.7 x 88	17.7 x 88
vessels per rotor	12	12	12	12	12	12	12	12	12	12	12	12	12	12
Cat. No.	2 x 1063-6 (6 pcs.)			6305	1054-A	1054-A	-	1054-A	1054-A	1054-A	-	-	-	-

Vessels

capacity in ml	1.6 - 5	4 - 7	8 - 10	8 - 10	5	15
Ø x L in mm	13 x 75	13 x 100	16 x 100	16 x 125	17 x 59	17 x 120
max. RCF ²⁾	13,201	16,582	16,582	16,582	12,718	15,455
radius in mm	82	103	103	103	79	96
Cat. No.	blood collection / urine vessels			-	-	-



Adapter

boring Ø x L in mm	13.5 x 60	13.5 x 79	17.7 x 88	17.7 x 88	17 x 25	17 x 104
vessels per rotor	12	12	12	6	12	6
Cat. No.	1054-A	1058	-	-	1064	1647^{2b)}

1) For cooled versions: Lowest temperature achievable with precooling and max. speed.

2) Please note that the RCF values indicated refer only to rotor performance. The max. permissible RCF of tubes used should be verified with the individual manufacturers. The max. RCF for glass tubes annotated with footnote 2) is 4,000.

— ANGLE ROTOR, 8-PLACE | 1418



Rotor

max. RPM max. RCF	4,500 min ⁻¹ 3,305
max. capacity	8 x 50 ml
run-up run-down, braked in sec	30 31
angle max. noise level	45° 54 dB (A)
temperature in °C ¹⁾	-11
Cat. No.	1418



Vessels

capacity in ml	5	15	1.1-1.4	2.6-3.4	2.7-3	9-10	1.6-5	4-7	8.5-10	12	15	50	12	50	50
Ø x L in mm	12x75	17x100	8x66	13x65	11x66	16x92	13x75	13x100	16x100	17x102	17x120	29x115	17x100	29x115	29x107
max. RCF ²⁾	2,762	3,215	2,762	2,762	2,762	3,215	2,762	3,305	3,215	3,215	3,283	3,147	3,215	3,147	3,147
radius in mm	122	142	122	122	122	142	122	146	142	142	145	139	142	139	139

Cat. No.	tubes ²⁾						blood collection / urine vessels				tubes with screw cap				
	+ 1054-A	+ 0716	+ 1054-A	+ 1054-A	+ 1054-A	+ 0716	+ 1054-A	+ 0716	+ 0716	+ E2109	+ E2110-A	+ 0716			
boring Ø x L in mm	17.4x91	17.4x91	17.4x91	17.4x91	17.4x91	17.4x91	17.4x91	17.4x91	17.4x91	17.4x91	17.4x91	30.2x92	17.4x91	30.2x92	30.2x92
vessels per rotor	32	32	32	32	32	32	32	32	32	32	32	8	32	8	8
Cat. No.	1467	1467	1467	1467	1467	1467	1467	1467	1467	1467	1467	1468	1467	1468	1468

1) For cooled versions: Lowest temperature achievable with precooling and max. speed.
 2) Please note that the RCF values indicated refer only to rotor performance. The max. permissible RCF of tubes used should be verified with the individual manufacturers. The max. RCF for glass tubes annotated with footnote 2) is 4,000.

CERTIFICATES / REGISTRATIONS



DOWNLOADS

[↓ Operating manual – UNIVERSAL 320 | 320 R](#)

[↓ General Catalog](#)

DIMENSIONS – UNIVERSAL 320

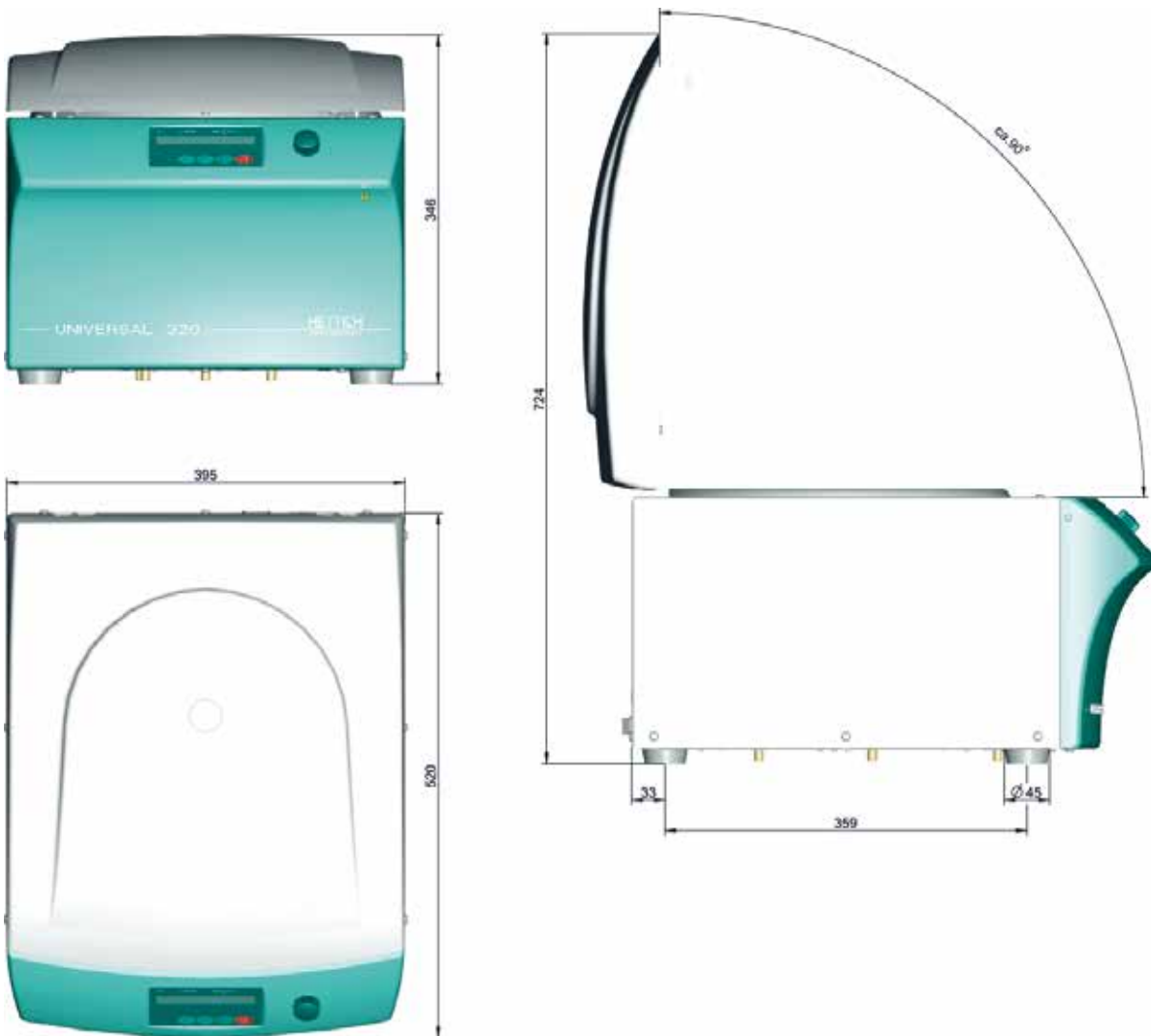

— DIMENSIONS – UNIVERSAL 320 R

